



**TOWER BRIDGE PRO**

**Excellent quality**



## 品系列 NSION BRIDGE PRODUCT SERIES

### Multi functional device to ensure safety and

The medical suspension bridges from the Brand Lekang embrace rich equipment manufacturing and integration and are designed following fit the actual application needs of doctors and patients. The products, operations, have great load-bearing ability and flexible movement and anti-rust treatments facilitate cleaning and disinfection to meet require

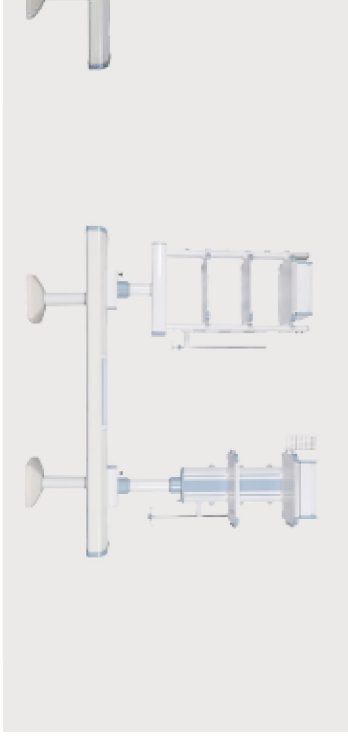

### Sturdy structure to increase load-bearing

The high-strength aluminum alloy materials and the design of 4-time products greater load-bearing ability and high fatigue resistance and allow long-term non-deformation and high load capacity to ensure the



### Modular production to match on demand

The beam length can be customized according to the actual length on sockets can be set on the beam or box as needed (figure of box on which beam combination, rotating arm function, complex tower and other offer



### ility

with a mechanical brake to realize humanized control and high load de range of 0-340° and the buffer limit device avoids violent impact

### or tender care

stable for operating by ICU medical care personnel; the trays and ible anti-collision corner protectors to avoid violent impacts; the better meet the requirement for sterile environment during surgery; apt to different instruments.

### er-proof and anti-fouling

and corro-  
om Akzo  
i-fouling

### ity,

area and  
n the two  
The gas  
d as  
bed on



### Superior materials for quality

The imported medical pipelines, plastic powder coating from Akzo No high-quality gas terminals (more than 20,000 times of plugging and u the device.

### chen hong suspension bridge for peace of r

The professional and efficient after-sales team creates a worry-free w design, advanced technology, modular combinations, and reliable pe pendent are your best choice.

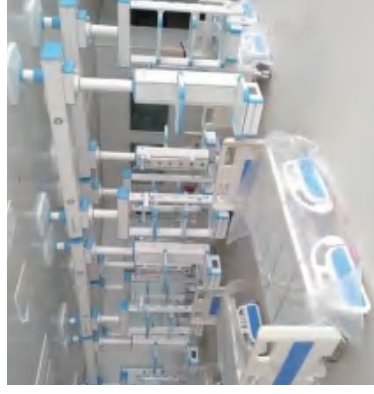

## Ergonomics design, convenient and safe

The medical pendant from the Brand Lekang are designed following principles that fit the actual application needs of doctors and patients. The design complies with the international medical electrical device safety standards and has great load-bearing ability and flexible movement and positioning, which is convenient for cleaning and disinfection of the products, to meet the requirements of clinical use.

## Separation of gas and electricity, reasonable

The box can be divided into a gas terminal area and an electrical terminal area to realize gas-electricity separation. The gas terminal and power socket terminal can be equipped on the beam or box optionally.

+

## 医用吊塔产品系列

SERIES OF MEDICAL PENDENT PRODUCTS

## Sturdy structure to increase load-bearing

The high-strength aluminum alloy materials and the design of 4-time greater load-bearing ability and high fatigue resistance and make the device non-deformation and high load capacity to ensure the safe use of device.

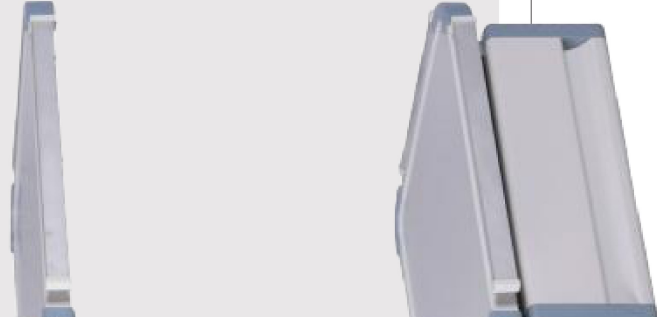
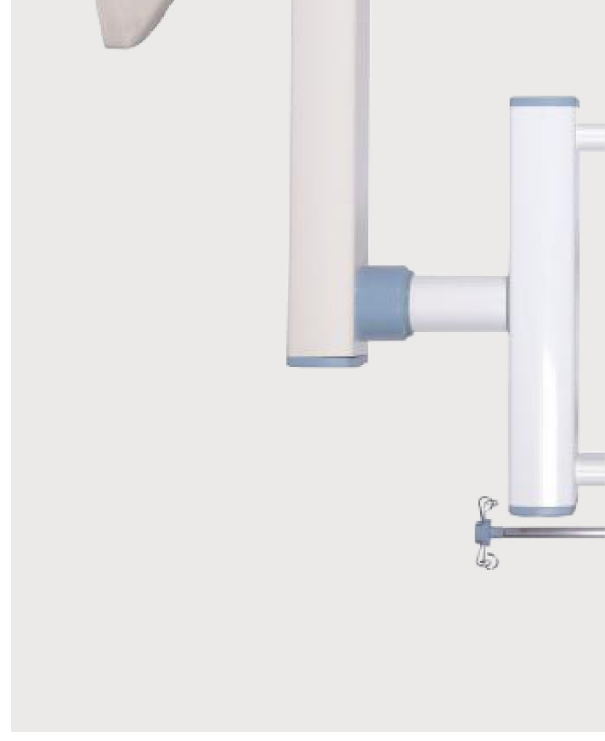

## able brake

d smooth lateral movement; both the gas-electric box and the  
ve a care radius of up to 1,4m and the rotation angle can be  
rage and standard mechanical brakes; optional pneumatic brakes  
r different needs to lock the tower body more firmly.

## clinical applications

arm types; single-tower, double-tower, multiple-tower types;  
al brake, pneumatic brake, electromagnetic brake; davit-type box,  
power socket, number and format of data ports; infusion rod arm,  
iform drawer reserved holes, etc. are all optional.

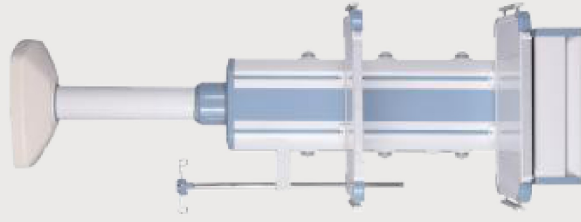

CH-G06 Multi functional Medical Column

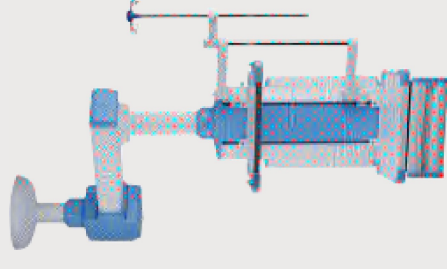

CH-G03 Single-Arm Electric Sugerial Tower

CH-G04

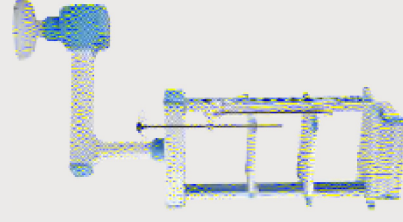

CH-G05 Single-Arm Electric Endoscope Tower

CH-G07

## Easy surface cleaning, water-proof and anti-fouling

The products are acid- and alkali-resistant and corrosion-resistant, enabled by power coating from Akzo Nobel on the surfaces and anti-rust and anti-fouling treatments inside and outside;

## Ergonomics design, convenient and safe

The trays and drawers are equipped with soft silicone flexible anti-collision corner protectors and the drawers are damped automatic rebound ones to avoid violent impact and better protect the safety of medical personnel and equipment.

## Superior materials for quality

The imported medical pipelines, plastic powder coating from Akzo Nobel and high-quality gas terminals (more than 20,000 times of plugging and unplugging) of the device.

## Chen Hong pendent for peace of mind

The professional and efficient after-sales team creates a worry-free environment. The design, advanced technology, modular combinations, and reliable performance are your best choice.



CH-G12 Double-Arm Mechanical Surgical Tower

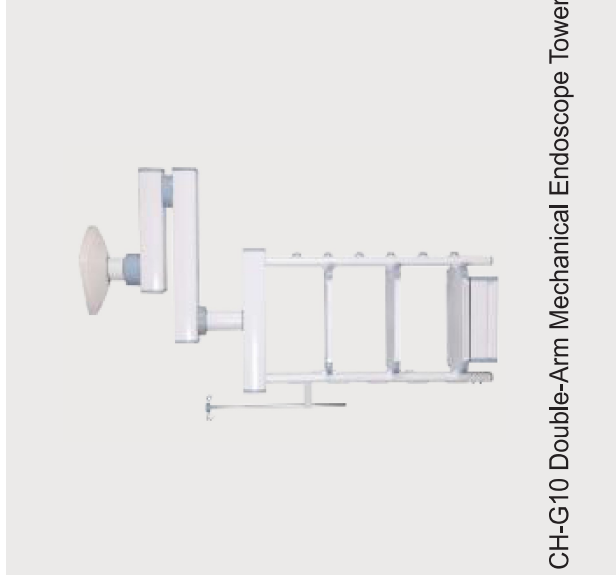

CH-G10 Double-Arm Mechanical Endoscope Tower

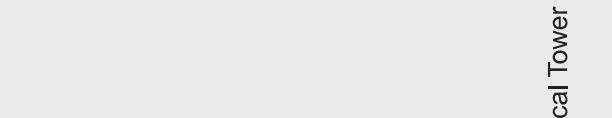

cal Tower

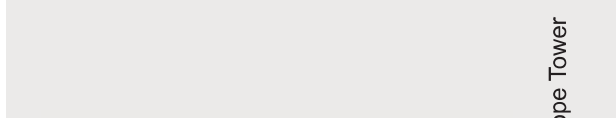

pe Tower